

# INW Roots blowers Operating Instructions



**INECO**<sup>®</sup>

**Air and Vacuum  
Components**

[www.in-eco.eu](http://www.in-eco.eu)

IN-ECO, spol. s r.o.  
Radlinského 13, 034 01 Ružomberok, Slovak Republic  
Telefón: +421/44/4304662, Fax: +421/44/4304663  
[www.in-eco.eu](http://www.in-eco.eu), e-mail: [info@in-eco.sk](mailto:info@in-eco.sk)



## **Contents**

<b>1 Safety</b>	<b>04</b>
1.1 Definitions	04
1.2 Safety alert symbol	05
<b>2 Principle of Roots Blower</b>	<b>06</b>
<b>3 Notice Of Operation and Maintenance</b>	<b>07</b>
<b>4 Installation</b>	<b>08</b>
<b>5 Operating Instruction</b>	<b>09</b>
<b>6 Operation trial</b>	<b>10</b>
<b>7 Safety valve adjustment</b>	<b>11</b>
<b>8 Maintenance and operating conditions</b>	<b>12</b>
<b>9 Troubleshooting</b>	<b>15</b>
<b>10 Construction and Spare Parts</b>	<b>17</b>
<b>11 Warranty</b>	<b>18</b>
<b>12 Waste disposal</b>	<b>18</b>

# 1 Safety

## 1.1 Definitions

To point out dangers and important information, the following signal words and symbols are used in these operating instructions:

## 1.2 Safety alert symbol

The safety alert symbol is located in the safety precautions in the highlighted heading field on the left next to the signal word (DANGER, WARNING, CAUTION). Safety precautions with a safety alert symbol indicate a danger of injuries. Be sure to follow these safety precautions to protect against injuries or death! Safety precautions without a safety alert symbol indicate a danger of damage.

## 1.3 Signal words

**DANGER**  
**WARNING**  
**CAUTION**  
**NOTICE**  
**NOTE**

The signal words are located in the safety precautions in the highlighted heading field. They follow a certain hierarchy and indicate (in conjunction with the safety alert symbol, see Chapter 1.2) the seriousness of the danger and the type of warning.

**See the following explanations:**

<p><b>⚠ DANGER</b></p> <p><b>Danger of injuries.</b>                      Indicates an imminently hazardous situation, that will result in death or serious injury if the corresponding measures are not taken.</p>	<p><b>⚠ WARNING</b></p> <p><b>Danger of injuries.</b>                      Indicates a potentially hazardous situation, that could result in death or serious injury if the corresponding measures are not taken.</p>	<p><b>⚠ CAUTION</b></p> <p><b>Danger of injuries.</b>                      Indicates a potentially hazardous situation, that may result in minor or moderate injury if the corresponding measures are not taken.</p>
<p><b>CAUTION</b></p> <p><b>Danger of damage.</b>                      Indicates a potentially hazardous situation that may result in property damage if the corresponding measures are not taken.</p>	<p><b>CAUTION</b></p> <p><b>Danger of damage.</b>                      Indicates a potentially hazardous situation that may result in property damage if the corresponding measures are not taken.</p>	<p><b>NOTICE</b></p> <p><b>Indicates a possible disadvantage, i.e.</b> undesirable conditions or consequences can occur if the corresponding measures are not taken.</p>
<p><b>⚠ WARNING</b></p> <p><b>Improper use of the unit can result in serious or even fatal injuries!</b></p> <p>These operating instructions:                      &gt; must have been read completely and understood before beginning any work with or at the pump-motor unit,                      &gt; must be strictly observed,                      &gt; must be available at the operating location of the pump-motor unit.</p>	<p><b>⚠ WARNING</b></p> <p><b>Improper use of the unit can result in serious or even fatal injuries!</b></p> <p>Transport and handling as well as assembly and disassembly of the unit may be carried out by trained and responsible personnel only!</p>	<p><b>NOTE</b></p> <p>Indicates a possible advantage if the corresponding measures are taken; tip.</p>

	<b>⚠ WARNING</b>
<p><b>When working on the unit, there is a danger of injury, e.g. in the form of cuts/ cutting off, crushing and burns!</b>                  During transport/handling as well as assembly and disassembly always wear personal protective equipment (safety helmet, protective gloves, safety boots)!</p>	

	<b>⚠ WARNING</b>
<p><b>Hair and clothing can be pulled into the unit or caught and wound up moving parts!</b>                  Do not wear long, loose hair or wide, loose clothes!                  Use a hair net!</p>	



	<b>⚠ DANGER</b>
<p><b>Electrical danger!</b>                  Before beginning work on the unit or system, the following measures must be carried out:</p> <ul style="list-style-type: none"> <li>&gt; Deenergize.</li> <li>&gt; Secure against being switched on again.</li> <li>&gt; Determine whether deenergized.</li> <li>&gt; Ground and short-circuit.</li> <li>&gt; Cover or block off adjacent energized parts.</li> </ul>	

	<b>⚠ DANGER</b>
	<p><b>Electrical danger!</b>                  Work on electrical installations may be carried out by trained and authorized electricians only!</p>

	<b>⚠ CAUTION</b>
<p><b>Danger of unit tipping over!</b>                  &gt; Secure the pump-motor unit on the installation surface before putting into operation!</p>	

	<b>⚠ WARNING</b>
<p><b>Hazard:</b> Long, loose hair can be drawn into external fan through fan guard grate, even with fan guard mounted!</p> <p><b>Protective measures:</b>                  Wear hair net!</p>	

	<b>⚠ WARNING</b>
<p><b>Danger from rotating external fan of unit!</b>                  Only operate the unit with the fan guard mounted!</p>	

 	<b>⚠ WARNING</b>
<p><b>Danger from rotating external fan of unit!</b>                  Only operate the unit with the fan guard mounted!</p> <p>It is prohibited to remove the fan guard!</p>	

	<b>⚠ WARNING</b>
<p><b>Danger in the form of cuts or cutting off extremities on the impeller of the pump-motor unit!</b>                  &gt; Do not reach into the unit through open connections!                  &gt; Do not insert objects into the unit through the openings!</p>	

	<b>⚠ WARNING</b>
<p><b>Danger due to gauge pressure and vacuum!</b>                  &gt; Check the connections of the pipe/hose connections for leaks!</p>	

	<b>⚠ WARNING</b>
<p><b>Danger due to gauge pressure and vacuum! Danger due to escaping fluid!</b> Check the connections of the pipe/hose connections for leaks!</p>	

	<b>⚠ WARNING</b>
<p><b>Danger of burns and scalding from hot surfaces of the pumpmotor unit and from hot fluids!</b>                  &gt; Do not touch during operation!                  &gt; Allow to cool after shut-down!</p>	

	<b>⚠ WARNING</b>
<p><b>Danger in the form of cuts or cutting off extremities on the impeller of the pump-motor unit!</b>                  &gt; Do not reach into the unit through open connections!                  &gt; Do not insert objects into the unit through the openings!</p>	

	<b>⚠ WARNING</b>
<p><b>Danger zone: Hot surface.</b>  <b>Hazard:</b>                  Burns/scalding possible.  <b>Protective measures:</b>                  Do not touch! Wear protective gloves!</p>	

## 2. Principle of Roots Blower

There are two lobes fixed on a set of synchromesh gear, the gap between two lobes, and the gap between lobes and the cylinder are very small. Since they do not touch each other, they do not need lubrication. Therefore, the transported air won't be polluted. Another advantage of no touch point is that the blower can run at high speed and draw more air.

Our product is very precise, and only gear need to be lubricated. The maintenance can reduce the damage of bearing and gear, and helps to maintain blower's life cycle.

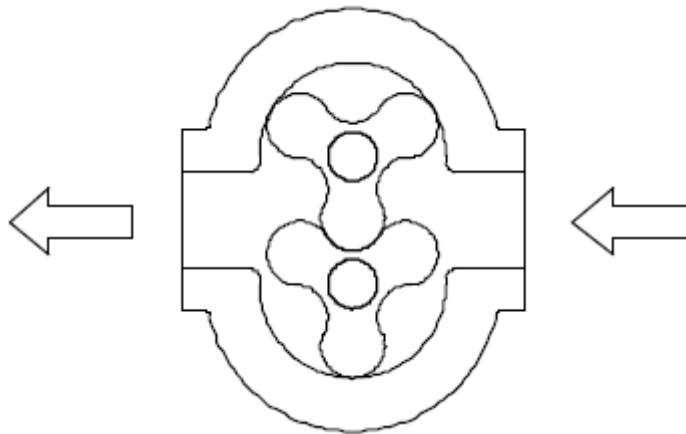

### 3. Notice Of Operation and Maintenance

- Ensure that cylinder is clean without any other things before operation.
- Ensure that installation and direction is correct.
- Inlet temperature should be under 40°C.
- Keep the time of changing oil acc. to the table on the page 12-13
- Ensure that gear oil level is normal. (Please see page 12-13)
- Please use proper gear oil for lubrication. (Please see page 12-13)
- Make sure safety valve work is in normal (Please see page 11)
- Please refer to (page 14) for all types of bearing and coupling
- To order parts, please see page 17

#### ! Restrictions !

Do not use INW roots blowers for taking in steam, or gas that contains a high volume of dust, charged particles, cellulose and particles larger than 40 µm.

Do not use INW roots blowers for compressing or pumping gases, which are explosive, flammable, aggressive or poisonous.

Do not use INW roots blowers in areas where explosive gases may emerge.

Do not use INW roots blowers for taking in water or other liquids. Prevent any liquids from entering INW roots blowers.

	<b>⚠ DANGER</b>
	<p><b>Electrical danger!</b> Before beginning work on the unit or system, the following measures must be carried out:</p> <ul style="list-style-type: none"> <li>- Deenergize.</li> <li>- Secure against being switched on again.</li> <li>- Determine whether deenergized.</li> <li>- Ground and short-circuit.</li> <li>- Cover or block off adjacent energized parts.</li> </ul>

	<b>⚠ DANGER</b>
	<p><b>Electrical danger!</b> The electrical connection may be carried out by trained and authorized electricians only!</p>

	<b>⚠ WARNING</b>
	<p><b>Danger due to gauge pressure and vacuum!</b> <b>Danger due to rotating parts!</b></p> <p>The pump-motor unit may only be put into operation when the following conditions are met:</p> <ul style="list-style-type: none"> <li>- Fan guard and vacuum pump/compressor housing are mounted.</li> <li>- The lines and connections have been tested for strength and leaks.</li> </ul>

## 4 Installation

**Installation and connection of the electrical part of the device may only be performed by a professionally qualified person with electrical engineering education.**

### - No need to make foundation base

There are 4 adjustable vibration isolators under the blower, they can keep blower steady on the ground without shaking. Therefore, it is no to make concrete foundation base.

### Ventilation, cooling

Ventilation and cooling is essential for the proper operation of the equipment. Leave at least 50 cm around equipment placed indoors for natural cooling.

If necessary (for example, if you use the equipment in a small area or within a soundproof housing), ensure the necessary air circulation (e.g. using a ventilator).

### - Movement

Please prevent the damage by collision or by shaking during the delivery. After moving, please check if the blower and its accessories are complete and the following check up is for your reference.

- (1) Check specification is same as purchase order when blower is arrived.
- (2) Check blower and screws are in good situation without damaged or loose.
- (3) Please lift / move blower with eye bolts which on blower.

### - Installation and Adjustment

Before plumbing, please seal the inlet port and outlet port of blower well, so that foreign matter will not fall into the blower.



### - Plumbing



(1) When plumbing, please pay attention for the followings to ensure the blower operates smoothly in the future.

(2) Please do not press pipes on the blower directly, so blower will not change its shape because heavy piping. The pipe which near the blower should be supported with suitable metal hanger ring or supporter. The central of pipe should be matched with central of blower, please do not tighten them forcedly. It would be better if add with a flexible joint, this can reduce the stress by deformed pipe and different temperature from piping.

(3) When the blower's inlet is opened, please put air filter to prevent anything to drop inside blower. Once they fall into the air cylinder, it will cause serious damages. When it is placed outdoor, please have a rain cover. Please add silencer on the inlet, outlet ports or pipe to reduce the noise. While conveyed air contains steam, it might congeal liquid during the process. Therefore, please have a drain hole at the bottom of plumbing.

- IN-ECO Silent Roots Blower is driven direct by coupling, it is no need to install pulley and belt. It is not only to save expense and time on belt changing, but also prevent pollution by waste belt powder.

 	 <b>WARNING</b>
	<p><b>Danger from tipping or falling loads!</b></p> <p>Prior to transport and handling make sure that all components are securely assembled and secure or remove all components the fasteners of which have been loosened!</p>

	 <b>WARNING</b>
	<p><b>Electrical danger!</b></p> <p>The pump-motor unit must be installed so that the electrical device cannot be damaged by external influences! In particular, the feed pipes must be securely routed, e.g. in cable ducts or in the floor.</p>



## 5 Operating Instruction

The company IN-ECO, spol. Ltd. reserves the right to make changes. The current version of the manual is published on the website [www.in-eco.eu](http://www.in-eco.eu).

### - Preparation

(1) Make sure blower is on a horizontal plane, then start motor to check it can move easily.

(2) Check the level of lubricating oil according to the manual

(3) Check that all the accessories are in the correct position and direction

(4) Open the control valve at inlet and outlet ports of the blower. The blower cannot be turned on while the valve is closed. There shall be the safety valves at inlet or outlet ports to protect the system and prevent the damages caused by wrong operation or resistance change from the system.

(5) Please install solenoid valve on power switch to avoid damaging the motor due to the electric current overload.

\*Special notice: Please check if the stop plate or sticker has been removed on flange of outlet.

	<b>⚠ WARNING</b>
	<p><b>Danger from lifting heavy loads!</b> Manual handling of the unit is only permitted within the following limits:</p> <ul style="list-style-type: none"> <li>. max. 30 kg [max. 66 lbs] for men</li> <li>. max. 10 kg [max. 22 lbs] for women</li> <li>. max. 5 kg [max. 11 lbs] for pregnant women</li> </ul> <p>For weights above the given values use suitable lifting appliances and handling equipment!</p>

	<b>⚠ CAUTION</b>
	<p>Danger of damage to the pump-motor unit due to overheating! When installing the unit, make sure that heat dissipation and cooling are not obstructed.</p>

	<b>⚠ DANGER</b>
	<p><b>Electrical danger!</b> Before beginning work on the unit or system, the following measures must be carried out:</p> <ul style="list-style-type: none"> <li>- Deenergize.</li> <li>- Secure against being switched on again.</li> <li>- Determine whether deenergized.</li> <li>- Ground and short-circuit.</li> <li>- Cover or block off adjacent energized parts.</li> </ul>

	<b>⚠ CAUTION</b>
	<p><b>Danger of crushing from unit tipping over!</b> In the unmounted state, the unit can easily tip due to its weight distribution! Wear gloves and safety shoes! Handle the unit with the appropriate care!</p>

	<b>⚠ CAUTION</b>
	<p>Danger of tripping and falling! Make sure the unit does not present a danger of tripping!</p>

	<b>⚠ DANGER</b>
	<p><b>Electrical danger!</b> The electrical connection may be carried out by trained and authorized electricians only!</p>

	<b>⚠ CAUTION</b>
	<p><b>Tipping or falling can lead to crushing, broken bones etc.!</b> <b>Sharp edges can cause cuts!</b></p> <p>Wear personal safety equipment (protective helmet, protective gloves, safety shoes) during transport!</p>

## 6 Operation trial

When you take operation trial, please ensure inlet pressure or outlet pressure is the same as the one shown on the name plate. If pressure needs to be changed, please adjust safety valve and notice the current load of motor. Inlet temperature must be kept within safety range. The highest inlet temperature of our standard roots blower is 40°C.

Please check the following items one by one while taking operation trial

- (1) Is rotating direction of the blower correct?
- (2) Is there any unusual noise?
- (3) To notice vibration situation of the blower
- (4) After operation trial, turn off the power to see if the blower can stop naturally.
- (5) Please check motor wire connection is correct voltage

If all above inspection are no problem, the formal operation can be arranged. At normal operation, there won't be too much maintenance, just pay attention on bearings (page 14 - Recommended interval of time for spare parts replacement) and lubrication of gear.

	<b>⚠ CAUTION</b>
	<p><b>Danger of crushing from unit tipping over!</b>                  In the unmounted state, the unit can easily tip due to its weight distribution!                  Wear gloves and safety shoes!                  Handle the unit with the appropriate care!</p>

	<b>⚠ WARNING</b>
	<p><b>Electrical danger!</b>                  The pump-motor unit must be installed so that the electrical device cannot be damaged by external influences!                  In particular, the feed pipes must be securely routed, e.g. in cable ducts or in the floor.</p>

	<b>⚠ CAUTION</b>
	<p>Danger of damage to the pump-motor unit due to overheating!                  When installing the unit, make sure that heat dissipation and cooling are not obstructed.</p>

	<b>⚠ CAUTION</b>
	<p>Danger of tripping and falling!                  Make sure the unit does not present a danger of tripping!</p>

	<b>⚠ DANGER</b>
	<p><b>Electrical danger!</b>                  Before beginning work on the unit or system, the following measures must be carried out:</p> <ul style="list-style-type: none"> <li>- Deenergize.</li> <li>- Secure against being switched on again.</li> <li>- Determine whether deenergized.</li> <li>- Ground and short-circuit.</li> <li>- Cover or block off adjacent energized parts.</li> </ul>

	<b>⚠ DANGER</b>
	<p><b>Electrical danger!</b>                  The electrical connection may be carried out by trained and authorized electricians only!</p>

## 7 Safety valve adjustment

The Roots Blower with safety valve has been adjusted according to customer's specification before delivery. In order to make sure blower and motor are safe, please double check safety valve is releasing pressure accurately before operation. If safety valve is not working as setted pressure or already changed necessary pressure, please adjust safety valve again.

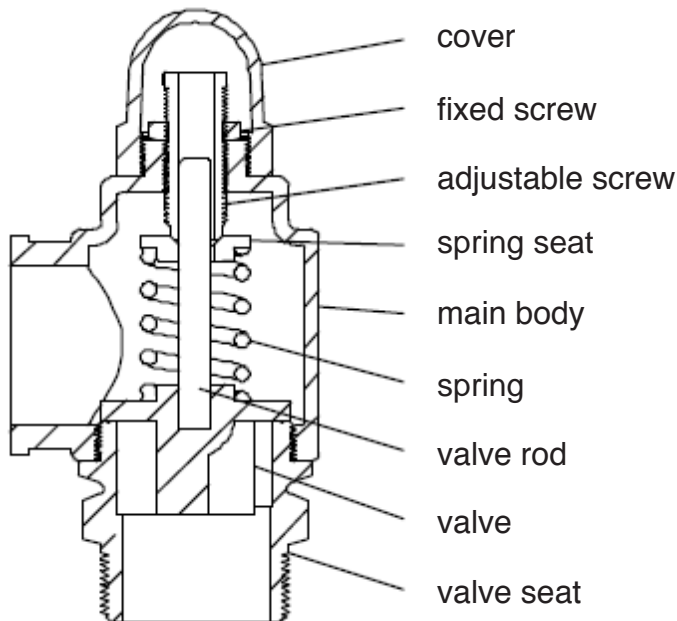

### - The adjustment steps are shown as following:

- (1) Release the valve cover
- (2) Release the fixed screw nut
- (3) Adjust by operation pressure
  1. Increasing the operation pressure: screw on
  2. Reducing the operation pressure: screw off
- (4) Accuracy test: if the safety valve releases the pressure at specific pressure
- (5) Tighten the fixed screw nut
- (6) Tighten the cover of safety valve
- (7) Double test the accuracy of safety valve for pressure release

## 8 Maintenance and operation conditions

### - Shaft seal

We use labyrinth type shaft seal for all our standard roots blowers, this shaft seal is not impact / touch directly with blower body, so it is not necessary to maintenance especially when blower is in normal operation.

### - Lubrication

#### (1) Gear oil changing time

Replace gear oil (drain old gear oil in advance, then fill up new gear oil)

First time: after 700 hours operation (About 30 days)

Future: after first time of replacing, the future replacing period is as following:

Operating Pressure	Oil Replacing Period
Below 400 mbar (4000mmAq)	Once every 1 years
Above 400 mbar (4000mmAq)	Once every 6 month

Please use full-synthetic gear oil if pressure is over than 0.6 kgf/cm<sup>2</sup> (6000mmAq). If ambient temperature is higher than 40 degree C, the period should be decreased half time.

#### (2) Volume of lubrication

Please check oil level anytime to have blower life longer. Please refer to the following oil volume and check oil gauge on oil box, the best volume is at middle line of oil gauge (please do not higher then 2/3 level) when blower stop running. If oil is too full, oil will overflow from the overflow orifice. If oil is too full to overflow, please clean the blower surface and dry the oil on the ground. After one hour, double check the drain plug is locked well and no leakage.

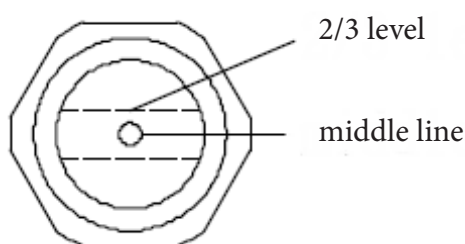

Model	Gear Oil Volume	Bearing (on driving side)
INW R40 – INW R45	850 ml	Using Sealed Bearing, No need to maintain
INW R50 – INW R60	2150 ml	
INW R65 – INW R80	2450 ml	
INW R90 – INW R125	5700 ml	
INW R150 – INW R160	11700 ml	

## Lubricating oil

Suggest to use LUBOL CLP 220 (or same level) gear oil #150 - #220 ( use for suction temperature is less than 40 °C).

Typical Physical Characteristics	Industrial Gear Oils
Flash Point COC, min.:	222 °C
Density at 20°C:	850 - 910 kg/m <sup>3</sup>
Kinematic Viscosity at 40°C:	198 - 242 mm <sup>2</sup> / s
Oxidizing properties:	Does not have
Pour Point, max.:	-15 °C

## Inspection

### (1) Daily control

Pressure of suction port and discharge port  
Electric current of motor  
Noisiness of the blower  
Oil level

### (2) Monthly control

Clean air filter in suction silencer  
Vibration  
Lubrication oil level - make sure no oil leakage

### (3) Every 6 months control

Sound of bearing, gear and lobes

## I Repair and replacement

With normal maintenance, the blower's life can be extended longer. In order to keep blower's life longer, some parts are requested to repair or replacement in time when parts are damaged.

Warranty do not cover parts, which are damaged under the normal operation conditions - filter cartridge, oil drain plugs, oil fill plugs etc.

Replacement of bearings is required every 36 months. The minimum service life of bearings is 15,000 operating hours, providing the operating conditions are respected.

Repairs shall only be carried out by an authorized IN-ECO service center during the warranty period. All warranty rights are forfeited if the equipment is tampered with during the warranty period. After the warranty has expired, send a blower to an authorized IN-ECO service center, because a repairment requires specialized knowledge.

Note: Replace lubrication oil timely is able to extend operating life longer.

### Coupling Rubber

Blower Model	Bearing model(on driving side)
INW R40 – INW R60	HRC70
INW R65 – INW R80	HRC90
INW R90 – INW R125	HRC110
INW R150 – INW R160	HRC130

### Recommended interval of time for spare parts replacement.

(pic. page 17, Construction and Spare Parts)

No.	Item	Need q'ty each time	Suggestion Replacement Time
12	Gear	2	every 5 year
7	Bearing	4	every 3 year
17	Packing	1	when change bearing
20	Oil gauge	1	every 2 years
2	Coupling	1	every 3 year
25	Pressure gauge	1	every year (depends on situation)
23	Inlet Silencer Air Filter	1	every 6 - 12 months (depends on situation)

## 9 Troubleshooting

Blower is not running	
Possible reasons for failure:	Solution:
Electrical wiring / lines error	Overhaul the electrical wiring / line
Motor is defective	Overhaul the motor
Foreign matter fall into the cylinder	Clean foreign matter away
Rotor get rust	Clean rust away
Gear is stuck by foreign matter	Clean foreign matter away
Inlet / outlet pipe line is clogged by foreign matter	Clean foreign matter away or open inlet / outlet valve
Outlet temperature is over heating	
Possible reasons for failure:	Solution:
Gear oil level is too over	Discharge oil to appropriate level
Filter is too dirty	Clean or change a new filter
Ambient temperature is too high	Install cooling system
Indoor air is poor cir culation	Open the door or window
Rotor clearance is eccentric	Send to plant to adjust rotor clearance
Bearing temperature is too high	
Possible reasons for failure:	Solution:
Oil level is too high	Discharge oil to standard level
Inappropriate lubricating oil	Change appropriate oil
Operating pressure is too over	Adjust pressure
Bearing is worn	Send to plant to change a new one
Bearing shaft is worn	Send to plant to change a new one
Gear oil temperature is too high	
Possible reasons for failure:	Solution:
Lubricating oil volume is too over or less	Fill or discharge oil to appropriate level
Inappropriate lubricant viscosity	Change appropriate oil
Gear is worn	Send to plant to change a new one
Gear clearance is too over	Send to plant to change a new one

Current is overload	
Possible reasons for failure:	Solution:
Blower speed is increased	Reduce Blower speed
Motor is breakdown	Overhaul the motor
Rotor get rust	Clean the rust away
Foreign matter fall into the cylinder	Clean the foreign matter away
Rotors impact each other	Sent to plant for adjusting gap
Rotor and cylinder wall impact each other	Sent to plant for adjusting gap
Unnatural noise	
Possible reasons for failure:	Solution:
Rotor and rotor impact each other	Sent to plant for adjusting gap
Rotor and cylinder wall impact each other	Sent to plant for adjusting gap
Gear is worn or jammed by foreign matter	Sent to plant to clean foreign matter away
Foreign matter fall into the cylinder	Clean foreign matter away
Coupling rubber is broken	Change a new coupling rubber
Bearing is worn	Sent to plant to change new bearing



## 10 Construction and Spare Parts

### Spare Parts

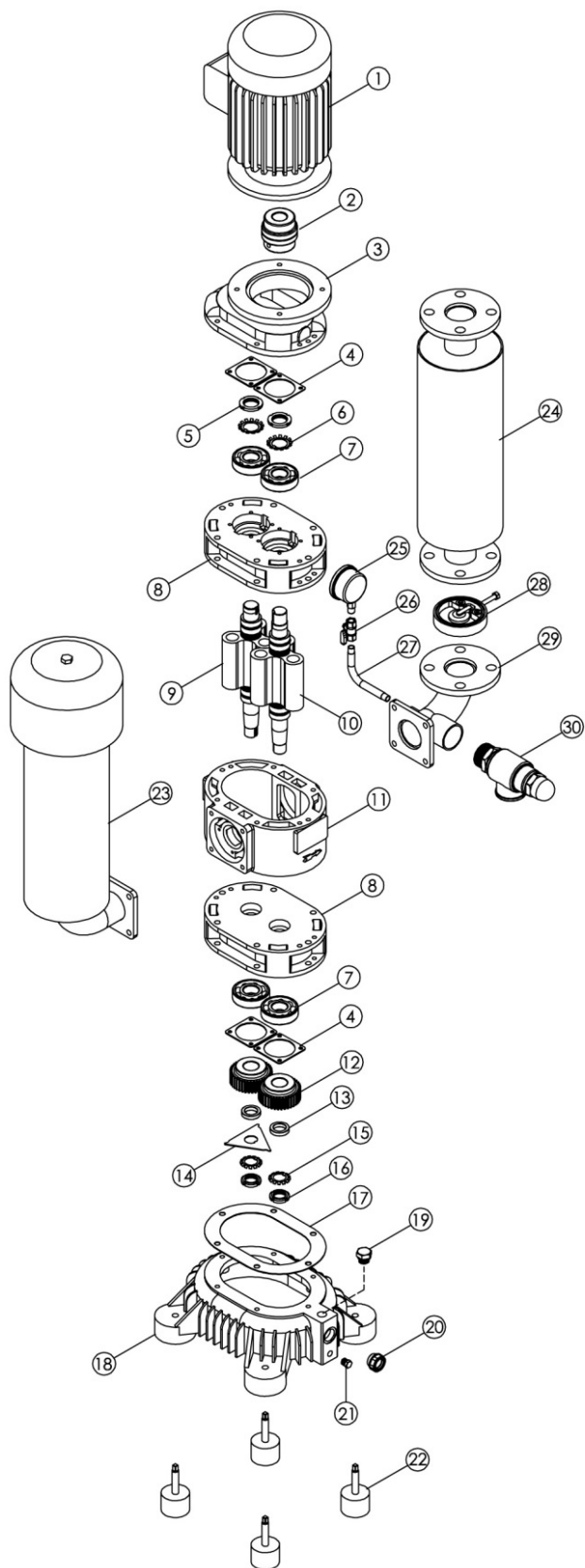

No.	Item	Qty
1	Motor	1
2	Coupling	1
3	Motor base	1
4	Bearing washer	4
5	Nut	2
6	Washer	2
7	Bearing	4
8	Bearing base	2
9	Rotor	1
10	Rotor	1
11	Main casing	1
12	Gear	2
13	Washer	2
14	Oil splash	1
15	Washer	2
16	Nut	2
17	Packing	1
18	Oil case	1
19	Oil plug	1
20	Oil gauge	1
21	Drain plug	1
22	Vibration isolator	4
23	Inlet silencer	1
24	Outlet silencer	1
25	Pressure gauge	1
26	Ball valve	1
27	Elbow joint	1
28	Check valve	1
29	Elbow joint	1
30	Relief valve	1

## 11 Warranty

Providing the warranty conditions are respected, IN-ECO provides a 2 year warranty on INW roots blowers.

### Warranty conditions

The equipment must be used (installed and operated) in accordance with this manual. Repairs shall only be carried out by an authorized IN-ECO service center during the warranty period.

All warranty rights are forfeited if the equipment is tampered with during the warranty period.

### The following must be included when returning the INW roots blower:

1. sales receipt (warranty),
2. description of how the equipment is used and the issue,
3. contact information: address, phone number, e-mail, etc.

Equipment returned or submitted for repair must be delivered clean.

Costs on transporting the equipment to the authorized IN-ECO service center and back to the customer are covered by the customer.

### The warranty expires:

if the conditions of installation and equipment operation are not observed,  
if the required maintenance is not respected,  
if the warranty conditions are not respected.

## 12 WASTE DISPOSAL

Valid legal waste management regulations must be observed for proper waste disposal.

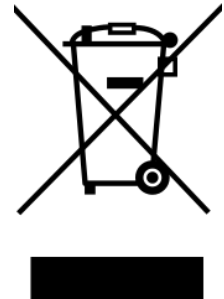



**INECO**<sup>®</sup>

**IN-ECO**, spol. s r.o.  
Radlinského 13  
034 01 Ružomberok  
Slovak Republic  
**T** +421 44 4304662  
**E** info@in-eco.eu  
www.in-eco.eu

9.6.2022